

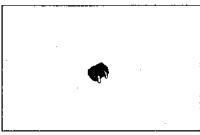

No. 1284

2SA1342/2SC3396



**SILICON PNP/NPN EPITAXIAL PLANAR TRANSISTOR
FOR SWITCHING APPLICATIONS
(WITH BIAS RESISTOR BUILT IN)**

Applications

Switching circuit, inverter, interface circuit, driver

Features

- Built-in bias resistor ($R_1=22k\Omega$, $R_2=22k\Omega$).
- Small-sized package (CP).

(): 2SA1342

Absolute Maximum Ratings/ $T_a=25^\circ\text{C}$

			unit
Collector to Base Voltage	V_{CBO}	(-)50	V
Collector to Emitter Voltage	V_{CEO}	(-)50	V
Emitter to Base Voltage	V_{EBO}	(-)10	V
Collector Current	I_C	(-)100	mA
Peak Collector Current	i_{cp}	(-)200	mA
Collector Dissipation	P_C	200	mW
Junction Temperature	T_j	150	$^\circ\text{C}$
Storage Temperature	T_{stg}	-55 to +150	$^\circ\text{C}$

Electrical Characteristics/ $T_a=25^\circ\text{C}$

			min	typ	max	unit
Collector Cutoff Current	I_{CBO}	$V_{CB}=(-)40\text{V}, I_E=0$			(-)0.1	μA
Collector Cutoff Current	I_{CEO}	$V_{CE}=(-)40\text{V}, I_B=0$			(-)0.5	μA
Emitter Cutoff Current	I_{EBO}	$V_{EB}=(-)5\text{V}, I_C=0$	(-)70	(-)113	(-)150	μA
DC Current Gain	h_{FE}	$V_{CE}=(-)5\text{V}, I_C=(-)5\text{mA}$	50			
Gain Band-width product	f_T	$V_{CE}=(-)10\text{V}, I_C=(-)5\text{mA}$		250 (200)		MHz
Output Capacitance	c_{ob}	$V_{CB}=(-)10\text{V}, f=1\text{MHz}$		3.5 (5.3)		pF
Collector to Emitter Saturation Voltage	$V_{CE(sat)}$	$I_C=(-)10\text{mA}, I_B=(-)0.5\text{mA}$	(-)0.1	(-)0.3		V

Marking on Device

2SA1342: CL, 2SC3396: CY

Electrical Connection

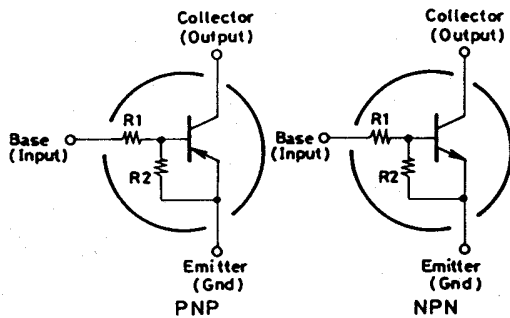

**Case Outline 2018
(unit: mm)**

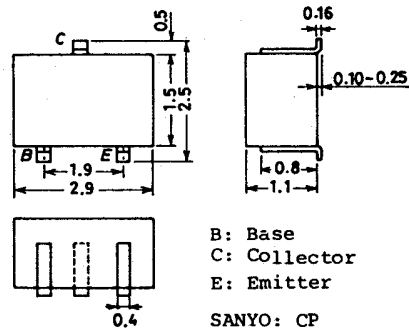

These specifications are subject to change without notice.

			min	typ	max	unit
Collector to Base Breakdown Voltage	$V_{(BR)CBO}$	$I_C=(-)10\mu A, I_E=0$	(-50)			V
Collector to Emitter Breakdown Voltage	$V_{(BR)CEO}$	$I_C=(-)100\mu A, R_{BE}=\infty$	(-50)			V
Input Off Voltage	$V_{I(off)}$	$V_{CE}=(-)5V, I_C=(-)100\mu A$	(-0.8)	(-1.1)	(-1.5)	V
Input On Voltage	$V_{I(on)}$	$V_{CE}=(-)0.2V, I_C=(-)5mA$	(-1.0)	(-1.9)	(-3.0)	V
Input Resistance	R_1		15	22	29	k Ω
Input Resistance Ratio	R_1/R_2		0.9	1.0	1.1	-

■ Sample Application Circuit

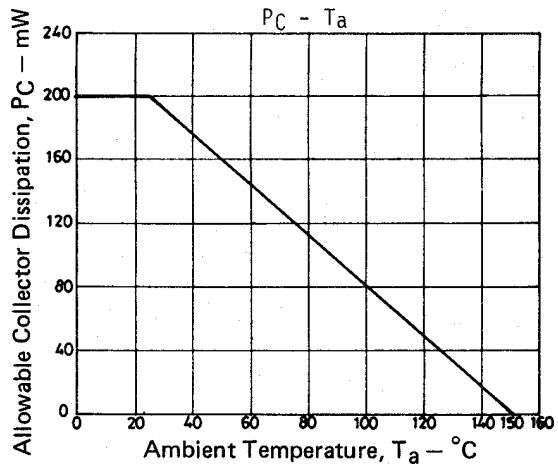
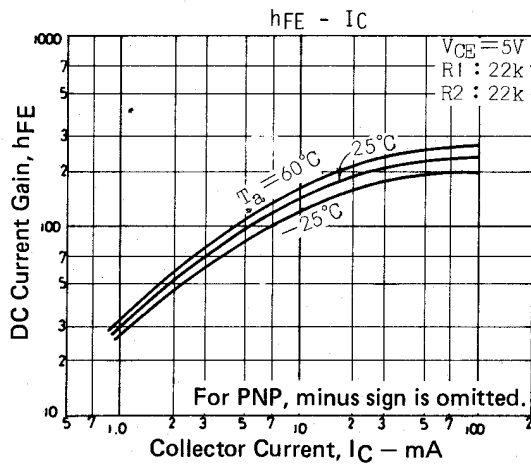
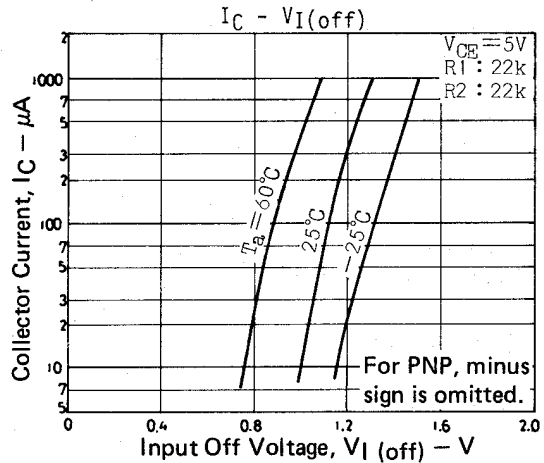
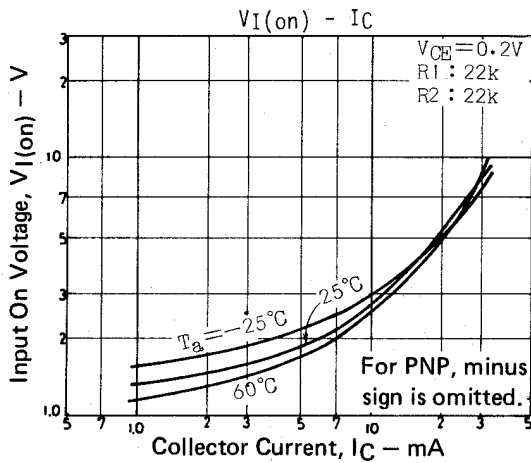
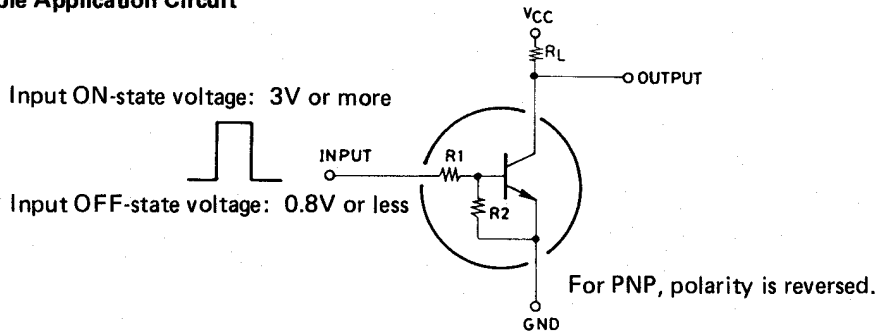

Information furnished by SANYO is believed to be accurate and reliable. However, no responsibility is assumed by SANYO for its use; nor for any infringements of patents or other rights of third parties which may result from its use, and no license is granted by implication or otherwise under any patent or patent rights of SANYO.